

CATV VSB Filter For TV Modulator (PAL B/G)

Part Number P7

Typical Performance

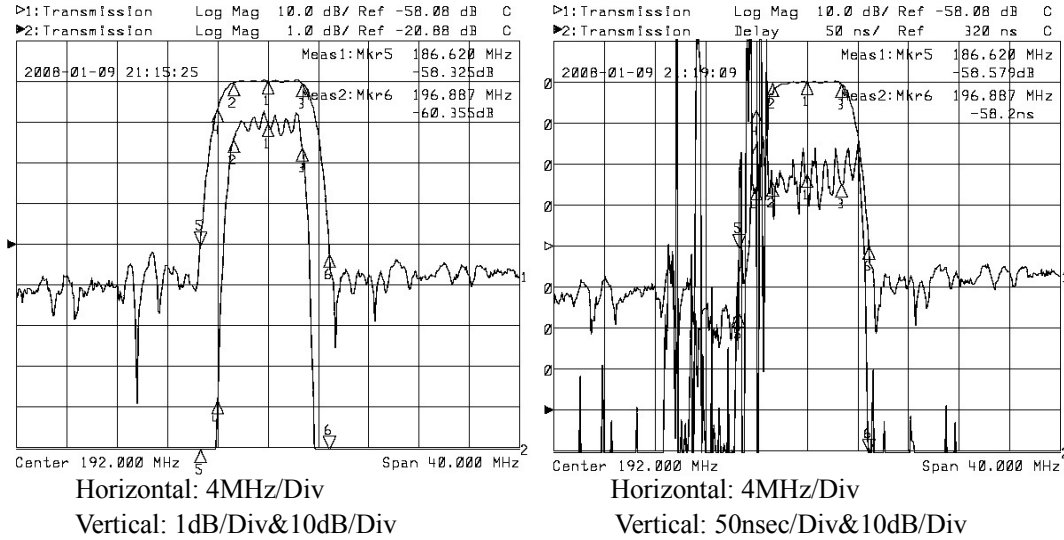

Specifications

Parameter	Unit	Minimum	Typical	Maximum
Center Frequency	MHz	191.50	192.00	192.50
Insertion Loss	dB		18.00	20.50
189.25MHz	dB		-0.50	-1.00
194.75MHz	dB		-0.80	-1.50
187.75MHz	dB	-10.00	-12.00	
196.25MHz	dB	-10.00	-14.00	
Passband Variation	dB		0.50	1.00
Group Delay Variation	nsec		70	100
Absolute Delay	usec		0.60	
Ultimate Rejection	dB	40	42	
Substrate Material	-		LiTaO3	
Ambient Temperature	°C		25	

Package SFA02

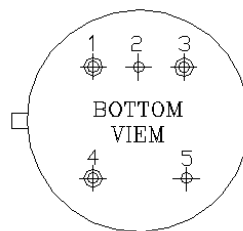
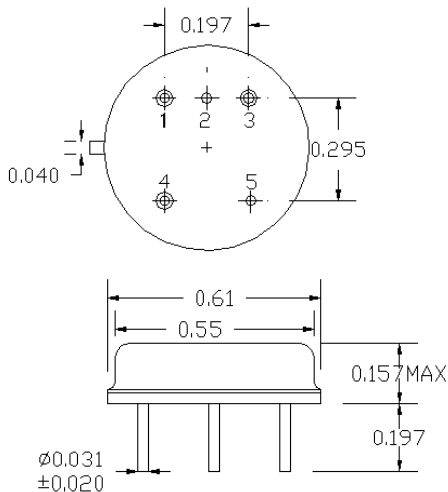

SFA02
 IN: 4
 OUT: 3
 GND: 1,2,5