

CATV VSB Filter For TV Modulator (PAL B/G)

Part Number P8

Typical Performance

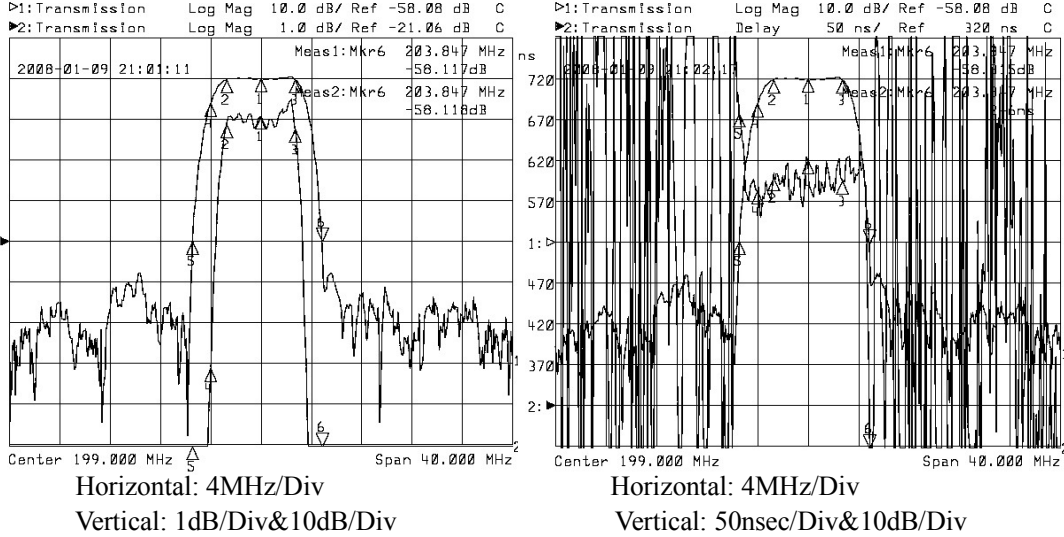

Specifications

Parameter	Unit	Minimum	Typical	Maximum
Center Frequency	MHz	198.50	199.00	199.50
Insertion Loss	dB		18.00	20.50
196.25MHz	dB		-0.50	-1.20
201.75MHz	dB		-0.50	-1.50
194.75MHz	dB	-8.00	-11.00	
203.25MHz	dB	-8.00	-12.00	
Passband Variation	dB		0.70	1.00
Group Delay Variation	nsec		50	100
Absolute Delay	usec		0.62	
Ultimate Rejection	dB	48	50	
Substrate Material	-		LiTaO3	
Ambient Temperature	°C		25	

Package SFA02

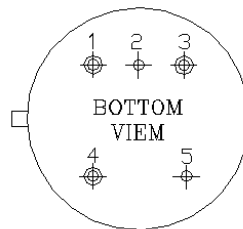
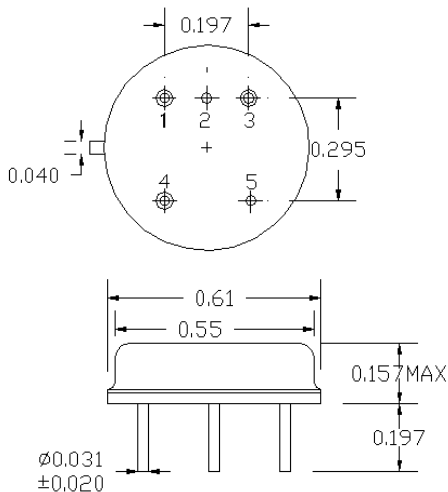

SFA02
 IN: 4
 OUT: 3
 GND: 1,2,5