

1. Specifications

Parameter	Unit	Minimum	Typical	Maximum
Center Frequency	MHz	479.50	480.00	480.50
Insertion Loss at F ₀	dB		18.00	19.20
1 dB Bandwidth	MHz	31.52	32.04	
3 dB Bandwidth	MHz	38.23	38.80	
40dB Bandwidth	MHz		63.30	63.96
Passband Variation	dB		0.60	0.80
Group Delay Variation	nsec		8	15
Absolute Delay	usec		0.20	0.21
Ultimate Rejection	dB	43	45	
Substrate Material	-		128LiNbO3	
Ambient Temperature	°C	-40	25	80

2. Typical Performance

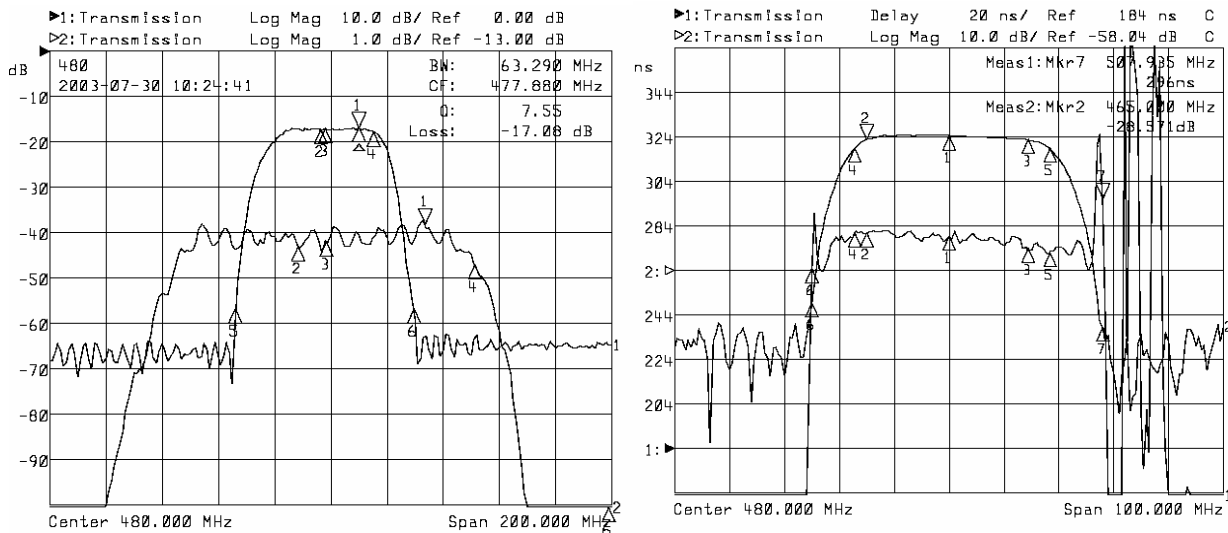

3. Package

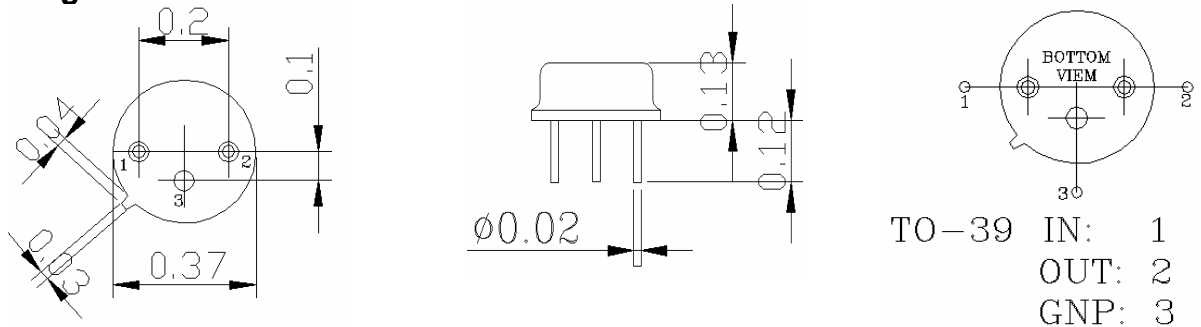

4. Marking

S480M370