

CATV VSB Filter For TV Modulator (PAL B/G)

Part Number P4

Typical Performance

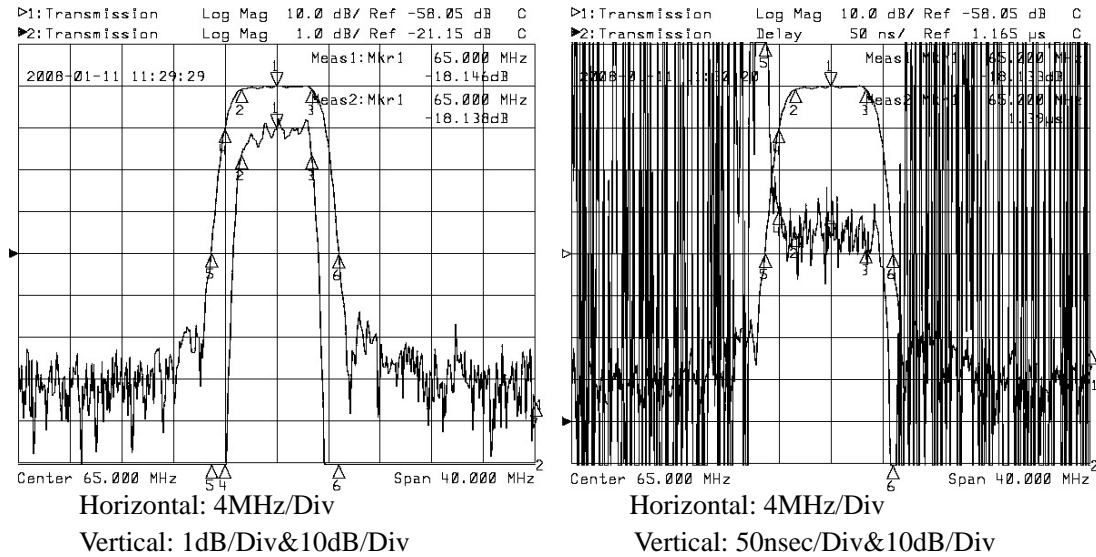

Specifications

Parameter	Unit	Minimum	Typical	Maximum
Center Frequency	MHz	64.50	65.00	65.50
Insertion Loss	dB		18.50	20.50
62.25MHz	dB		-0.50	-1.00
67.75MHz	dB		-0.80	-1.50
60.75MHz	dB	-10.00	-13.00	
69.25MHz	dB	-18.00	-20.00	
Passband Variation	dB		0.70	1.00
Group Delay Variation	nsec		70	100
Absolute Delay	usec		1.39	
Ultimate Rejection	dB	50	55	
Substrate Material	-		128-LiNbO3	
Ambient Temperature	°C		25	

Package SFA02

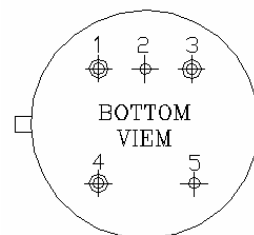
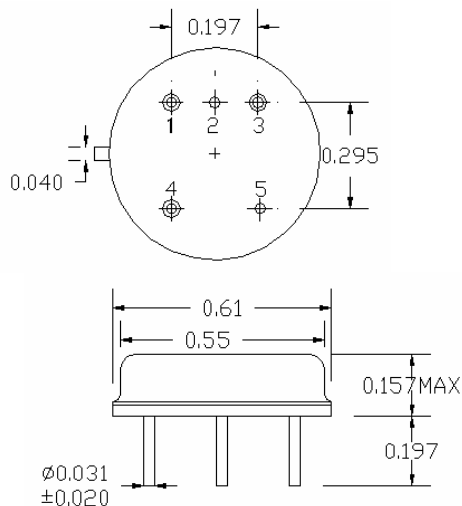

SFA02
IN: 4
OUT: 3
GND: 1,2,5